

# ***STRAIN GAUGES***

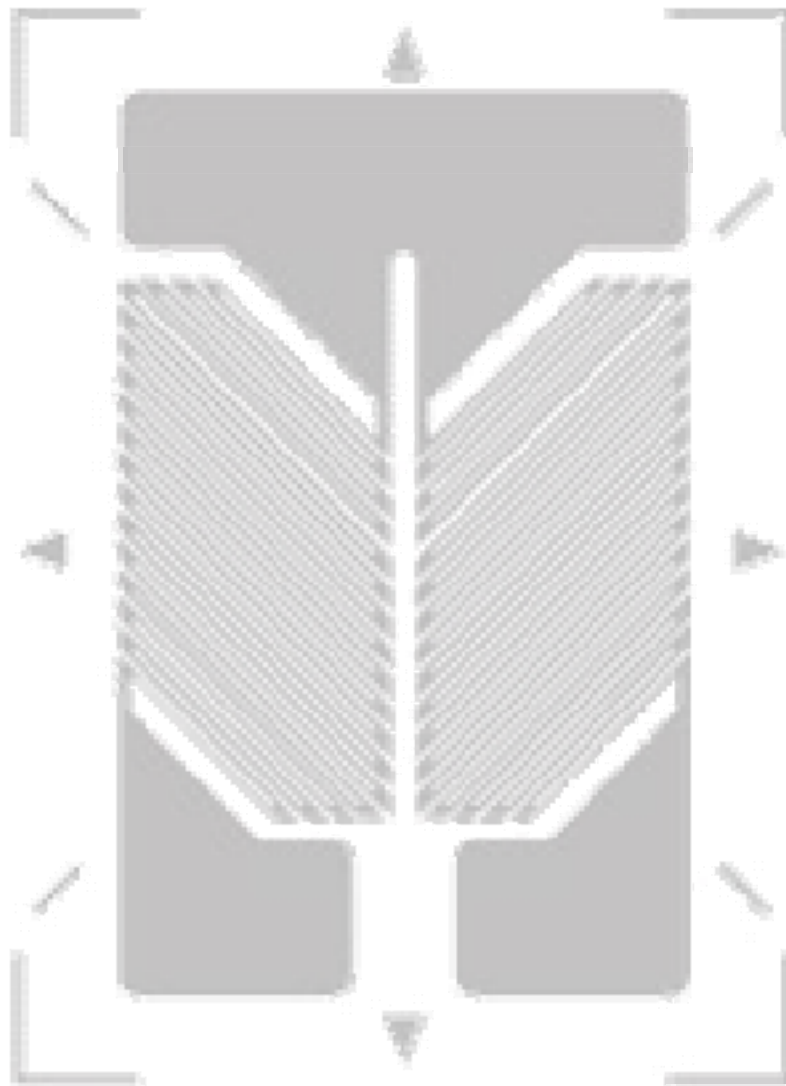

**QuanYuan Electronic Co., LTD**

## THE SELF-COMPENSATION OF STRAIN GAUGE

### I .Temp. Self-compensation

The hypostasis of Zero Output is the Potential Discrepancy of load cell between two output terminals, and the Potential rest with the two Electric Bridge's resistance. The working Temp. of this Electric Bridge's resistance change as well as the Zero Output of load cell, so this change about the Zero Output of load cell called Zero Excursion(P).

Why the Electric Bridge's resistance will be change when the Temp. change? To strain gauge, it is affected by its Heat Output. Heat Output is the strain gauge installed on the unfettered specimen, no force, when the environmental Temp. Changes occur as a chance in its resistance. So the ideal of strain gauge is the Heat Output approach Zero. This kind of strain gauge is Temp. Self-Compensation Strain Gauge. But it is opposite speaking to Self-Compensation, this Temp. Self-Compensation Strain Gauge also have Heat Output, just it is less than others.

We always change the materials of Sensitive Grids and change the Resistance Temp. Coefficients by heat treatment make to make the Heat Output of strain gauge to approach Zero. We synthesize the function relations which among Elastomer linear expansion coefficient, Foils linear expansion coefficient, Resistance Temp. Coefficient and Temperature, with suitable heat treatment to produce Self-Compensation strain gauge which linear expansion coefficient is 9,11,16,23.

Remark: "11" is suit for alloy steel, Martensite stainless steel, Precipitation

Hardening stainless steel etc.. "16" is suit for Austenitic Stainless Steel etc.. "23" is suit for Aluminium alloy etc...

### II .Creep Self-compensation

All metal will bring spring aftereffect, it says when the metal have force in its spring scope, it distort and will not balance with its load at once, but a little later; after retract the force, it also will not distort to original state at once, but a little later, it will become the same. So this will show by Positive

## TECH SUPPORT

---

Creep that the output signal of load cell increase as the time increase. The output signal also will Negative Creep, because the fundus and slice will slack (By stated stress will decreased by time), and the value can be adjusted by change the configuration of Sensitive Grids, the materials of fundus and produce technics. If the absolute value of Positive Creep is the same as the Negative Creep, then the Creep of the load cell can Self-compensate to the best. Our company produces different Creep grade strain gauge to satisfy our clients.

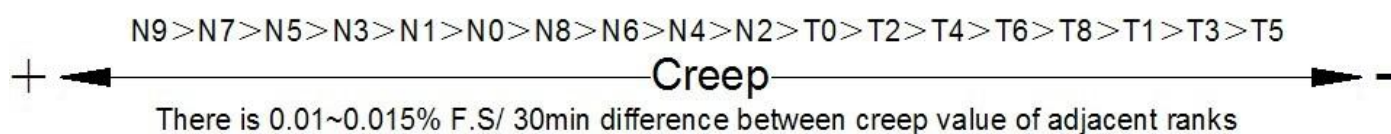

### III.Elastic Modulus Self-compensation

In elastomer, elastic modulus decrease with the raise of the ambient Temp., and the output of the load cell increase with the raise of the Temp. We adjust the heat treatment of Sensitive Grids to make the Sensitive coefficient K decrease with the raise of the Temp., in order to counteract the increase which brought by the elastic modulus decrease with the raise of the Temp. at last to achieve Self-compensation, this strain gauge is called Elastic Modulus Self-compensation Strain Gauge. It synthesize both effects about common strain gauge and Self-compensation elastic modulus, good stability, low cost, high sensitivity, easy to produce and work, it is also suit for load cell which the precision grade is 0.05 or mass production and low cost.

## SELECT AND USE STRAIN GAUGE

There are many kinds of strain gauges with different performance. We should consider many reasons to select and use the best strain gauge, first, we need to consider the terms of experiment and usage (Use precision, Environment conditions: temperature, humidity, atrocious environment,

## QY Electronic Co., Ltd

Address: The Middle of North Tuanjie Street, Hantai District, Hanzhong City, Shaanxi Province China. Fax: +86-0916-2257989  
Website: [www.qysensor.com](http://www.qysensor.com) Zip: 723000

interference, stick area, install condition, specification of materials etc.); Second, we should consider the parameters of the goods (Expansion Coefficient, Elastic Modulus, Forced or Stress Distribution etc.). The ways to select and use as below:

## **I . Types to select**

We should select strain gauge according to the tested purpose, the materials and precision demands of the tested goods. For example, the sense organ of the load cell, then it need to select the Foil strain gauge which is small P and  $\theta$ ; If the sensitivity of the load cell needs to be large, then we should select Semiconductor strain gauge; we should select Foil strain gauge if we test the dynamic weighing.

## **II . The fundus materials of the Sensitive Grids**

How to select the best and suitable Sensitive Grids or fundus materials? First, we should according to the environment, temperature, tested time and the ultimate straining, then we also need to consider the precision demand of the strain gauge, For example: In  $-30\sim+80^{\circ}\text{C}$ , you should choose CuNi, NiCrFe or Phenolic strain gauge; And in  $80\sim150^{\circ}\text{C}$ , then use Polyimide strain gauge is better.

## **III. The resistance of strain gauge**

We consider and select the resistance of strain gauge according to the demands which the test equipment require to the resistance and sensitivity of strain gauge etc. For example, in the stress test, we usually use  $120\Omega$  train gauge to match the equipment; To the load cell, we use high resistance ( $350\Omega$ ,  $500\Omega$ ,  $1000\Omega$  even larger etc.) to improve its stability and sensitivity, sometimes we also consider the performance and the values and the function, we use high resistance strain gauge.

## **IV. Dimension of strain gauge**

We decide the dimension of strain gauge according to the materials, stress and the stucked area.

## TECH SUPPORT

---

For example, we use longer grids strain gauge if the stress is proportional or the changing is small, and it allow to stick on a large area, in this condition, we suggest to use 3~6mm's grids; but we use the grids length $\leq$ 1mm, if the stress is collected in area or the sticked area is small. The long grids strain gauge is good for stick, connection and good cool function; it also can improve the performance of the strain gauge. The dimension of the strain gauge is smaller, the demands of strict quality are higher, and the cool function is weaker, so on conditions of insure the precision and have enough sticked area, it is better to use long grids strain gauge.

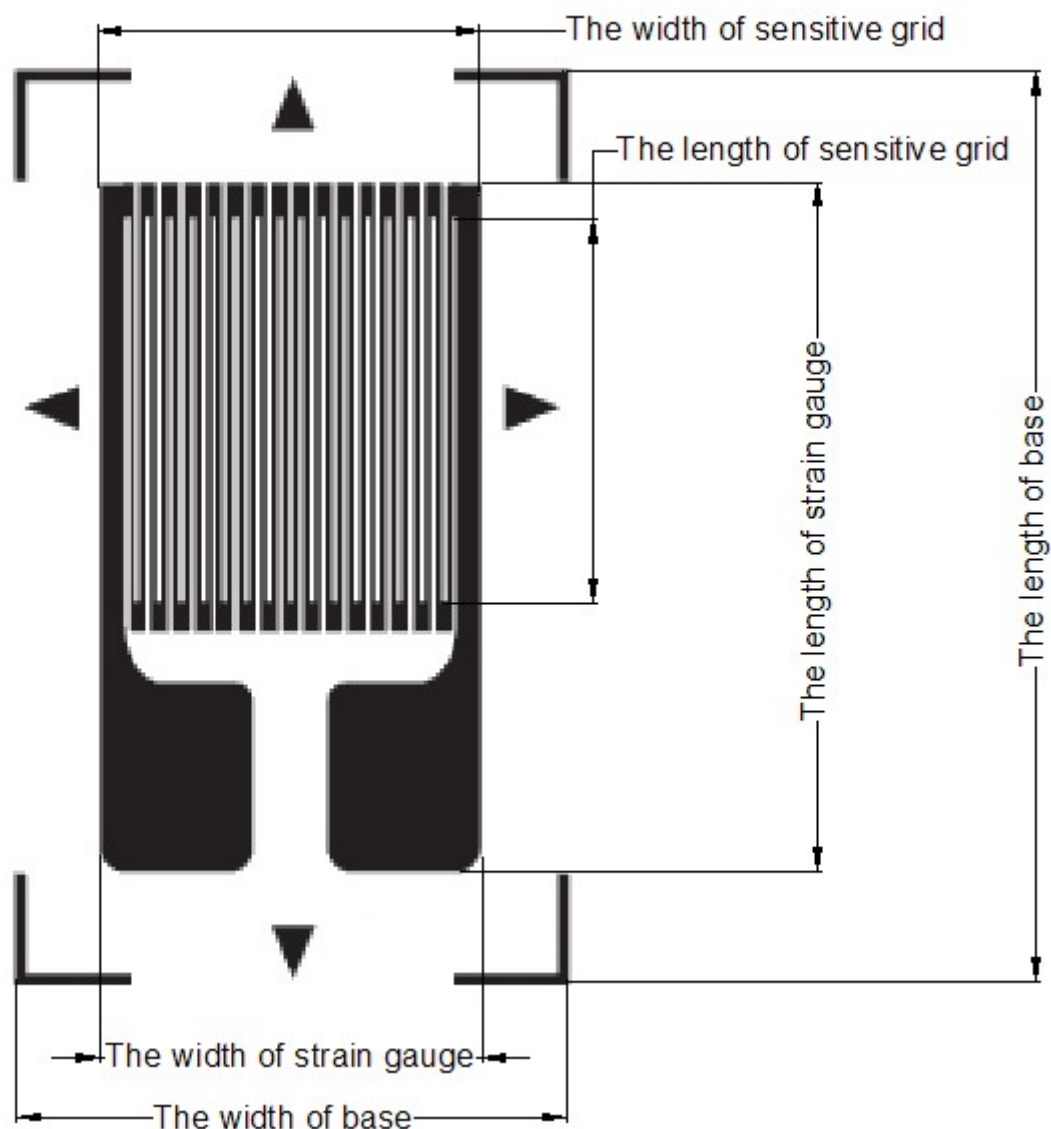

## QY Electronic Co., Ltd

Address: The Middle of North Tuanjie Street, Hantai District, Hanzhong City, Shaanxi Province China. Fax: +86-0916-2257989  
Website: [www.qysensor.com](http://www.qysensor.com) Zip: 723000

## **V. The configuration of the Sensitive Grids**

We select the configuration of the Sensitive Grids according to the stress and other demands. Like when the main stress is unknown or shear strain, then we can select multi-axes strain gauge, we use these strain gauge which Triaxial angle are 45°, 60° or 120° for the first situation; And use Triaxial angle is 45° for another situation. If we test the know stress strain, then we can select Uniaxial strain gauge; the circle multi-axes strain gauge is used in Pressure sensor.

## **VI. Temp. Self-compensation and Elastic Modulus self-compensation**

We should select different Temp. Self-compensation or Elastic Modulus self-compensation strain gauge according to its materials, working Temp. and the precision. Like some common steel or spring steel, then use Temp. Self-compensation strain gauge with the  $11 \times 10^{-6}/^{\circ}\text{C}$  expansion coefficient; And to the Aluminum alloy, then use strain gauge with  $23 \times 10^{-6}/^{\circ}\text{C}$  expansion coefficient.

## **VII. Creep Grade**

The user should select the matching Creep Grade according to the configuration, capacity and Elastomer of the load cell. First time we can select one or two kind of different Creep Grade's strain gauge to test, and according to the last test data, and then select the best Creep Grade.

# TECH SUPPORT

The Performance and Quality Standard of Strain Gauge		
Working Speciality	Specification	Factory Standard
Resistance	Error to Nominal Value	$\leq \pm 0.5\%$
	Tolerance to Value	$\leq \pm 0.1\%$
The Sensitivity Coefficient	The Sensitivity Coefficient	CuNi Series: 2.0~2.2 NiCrAiFe & NuCrAiCu Series: 2.0~2.4
	Dispersion Scope to Average	$\pm 1\%$
Heat Output	Output Coefficient on Average	$1_{\mu}m/m/^{\circ}C$
	Dispersion Scope to Heat Output	$\leq 50_{\mu}m/m/^{\circ}C$
Insulation Resistance	Room Temp.	$10^4 M\Omega$
Fag Life	Room Temp.or Utmost Temp.	$\geq 10^7$
Working Temp.	BF Series	$-30\sim+80^{\circ}C$
	BA Series	$-30\sim+150^{\circ}C$
	BE Series	$-30\sim+150^{\circ}C$

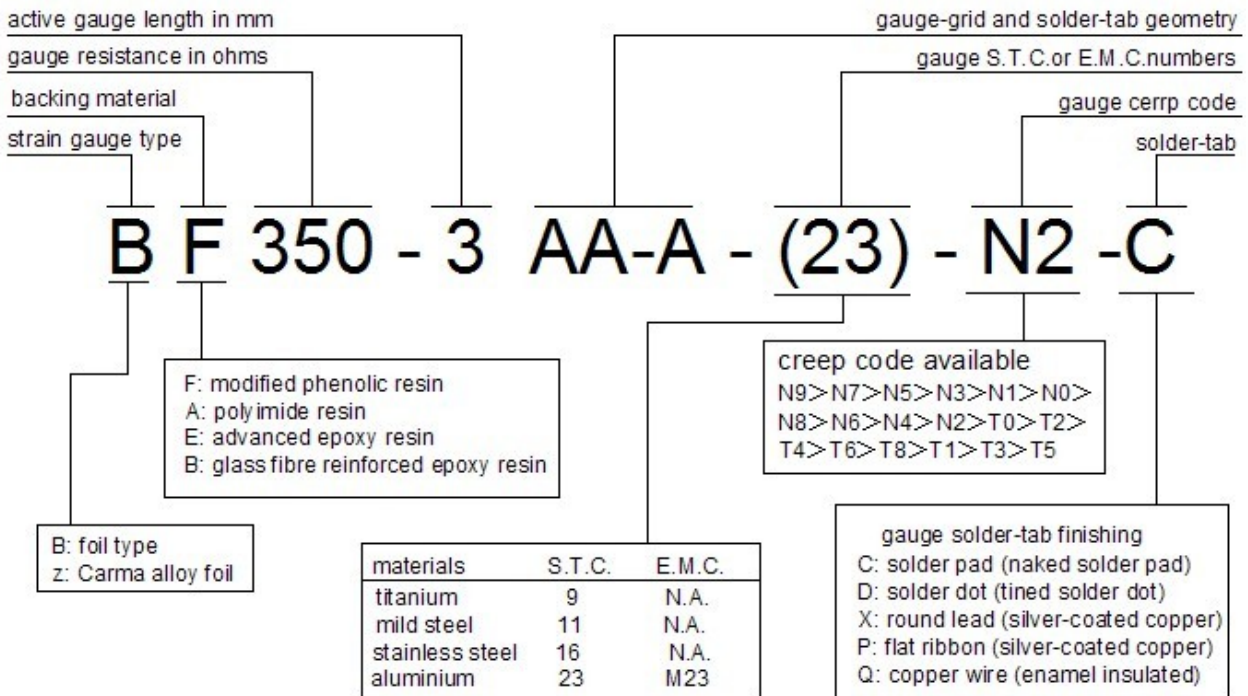

## QY Electronic Co., Ltd

Address: The Middle of North Tuanjie Street, Hantai District, Hanzhong City, Shaanxi Province China. Fax: +86-0916-2257989  
Website: [www.qysensor.com](http://www.qysensor.com) Zip: 723000

# TECH SUPPORT

## AA Series Strain Gauge

### CONSTRUCTION DRAWING

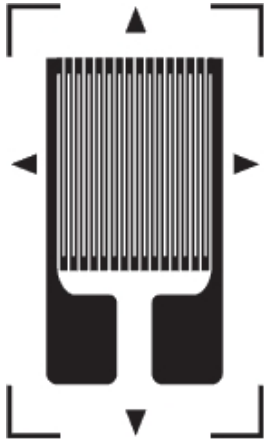

### PRODUCT MODEL TABLE (Unit: mm)

MODEL	GRID DIM		BACKING DIM		CREEP
	L (mm)	W (mm)	L (mm)	W (mm)	
BF120-3AA(**)	2.8	2	6.4	3.5	N8,N6,N3,N1,N0
BF240-3AA(**)	3.2	3.06	7.4	4.5	N8
BF(BA)300-3AA(**)	2.9	1.8	5.5	2.5	
BF(BA)350-1AA(**)	1.5	2.5	4.5	3.5	N3,N0,N8,N6,N4, N2,T0,T2,T4,T6,T8
BF(BA)350-2AA-A(**)	2.4	3	5	4	
ZF350-2AA(**)	1.9	2.8	5.6	4	T6,T4,T0, N8,N6,N4,N1,N0
BF(BA)350-2AA-P(**)	2	2.4	5	3.5	N0,N2, T0,T2,T4,T6,T8
BF(BA)350-2AA(**)					N9,N7,N5,N3,N1,N0,
ZF1000-2AA(**)	2.5	3.3	6.5	4.5	N8,N6,N4,N2,T0, T2,T4,T6,T8,T1
ZF1000-3AA-B(**)					N7,N6,N5,
ZF350-3AA-B(**)	3	3.1	14.2	4.5	N3,N2,N1,N0, T8,T4,T3,T2
BF350-3AA-A(**)	3.2	1.6	6.9	3	N8,N6
					N9,N7,N5,N3, N1,N0,N8,N6,N4, N2,T0,T2,T4,T6, T8,T1,T3,T5
BF(BA)350-3AA(**)	3.2	3.1	7.5	4.5	
ZF350-3AA(**)	3.2	3.2	7.5	4.5	N0,N8,N6,N4,N2
ZF1000-3AA(**)	3.1	2.6	7.5	4	T4,T0, N6,N5,N4,N3,N1,N0
BF(BA)350-4AA(**)					N9,N7,N5,N3,
ZF1000-4AA(**)	3.8	2.7	8.2	4.2	N1,N0,N8,6,N4,N2, T0,T2,T4,T6,T8
BF(BA)350-5AA(**)					
ZF1000-5AA(**)	5	2.9	9.2	4.5	
ZF1000-1.5AA(**)	1.5	4	5	5.2	T8
ZF1000-1.5AA-A(**)	1.5	2.5	4.5	3	T8
BF1000-2AA(**)	2.2	4.6	5.8	5.8	N0,N6,T6,T8

## QY Electronic Co., Ltd

Address: The Middle of North Tuanjie Street, Hantai District, Hanzhong City, Shaanxi Province China. Fax: +86-0916-2257989  
 Website: [www.qysensor.com](http://www.qysensor.com) Zip: 723000



# TECH SUPPORT

ZF1000-2AA-A(**)	2.1	3.3	5.8	4.5	T8
BF(BA)1000-3AA(**)	3	5.3	6.8	6.5	N3,N1,N8,N6,N4,
BF(BA)1000-4AA(**)	4	4.3	7.8	5.5	T0,T2,T6
BF(BA)1000-6AA(**)	6	4	10	5.5	

## AB Series Strain Gauge

CONSTRUCTION DRAWING



PRODUCT MODEL TABLE (Unit: mm)

MODEL	GRID DIM		BACKING DIM		CREEP
	L (mm)	W (mm)	L (mm)	W (mm)	
BF350-1AB	1.6	1.5	9.6	2.7	
BF350-3AB	3.8	3.1	8.0	4.1	
BF1000-3AB	3.8	3.1	8.0	4.1	

## BB Series Strain Gauge

CONSTRUCTION DRAWING

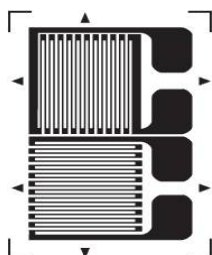

PRODUCT MODEL TABLE (Unit: mm)

MODEL	GRID DIM		BACKING DIM		CREEP
	L (mm)	W (mm)	L (mm)	W (mm)	
BF350-2BB	2.6	3.3	6.3	7.6	
BF350-3BB	3.0	3.0	6.8	7.6	
ZF1000-2BB	2.6	3.0	6.3	7.5	
ZF1000-3BB	3.0	3.0	6.8	7.6	

## BB-A Series Strain Gauge

CONSTRUCTION DRAWING

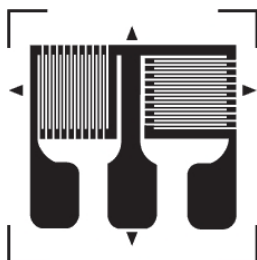

PRODUCT MODEL TABLE (Unit: mm)

MODEL	GRID DIM		BACKING DIM		CREEP
	L (mm)	W (mm)	L (mm)	W (mm)	
BF350-3BB-A	3.0	3.0	6.8	7.6	
ZF1000-3BB-A	3.0	3.0	6.8	7.6	

## QY Electronic Co., Ltd

Address: The Middle of North Tuanjie Street, Hantai District, Hanzhong City, Shaanxi Province China. Fax: +86-0916-2257989

Website: [www.qysensor.com](http://www.qysensor.com)

Zip: 723000

# TECH SUPPORT

## EB Series Strain Gauge

CONSTRUCTION DRAWING

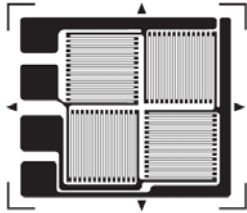

PRODUCT MODEL TABLE (Unit: mm)

MODEL	GRID DIM		BACKING DIM		Distance to Center mm
	L (mm)	W (mm)	L (mm)	W (mm)	
BF350-3EB	2.3	2.7	9.2	7.7	
ZF1000-3EB	2.3	2.7	9.2	7.7	

## EB-A Series Strain Gauge

CONSTRUCTION DRAWING

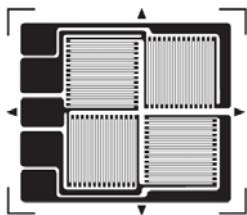

PRODUCT MODEL TABLE (Unit: mm)

MODEL	GRID DIM		BACKING DIM		Distance to Center mm
	L (mm)	W (mm)	L (mm)	W (mm)	
BF350-3EB-A	2.3	2.7	9.2	7.7	
ZF1000-3EB-A	2.3	2.7	9.2	7.7	

## FB Series Strain Gauge

CONSTRUCTION DRAWING

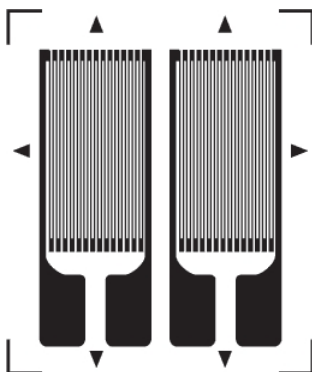

PRODUCT MODEL TABLE (Unit: mm)

MODEL	GRID DIM		BACKING DIM		CREEP
	L (mm)	W (mm)	L (mm)	W (mm)	
BF350-2FB(**)	2.0	3.2	5.7	7.6	
BF350-3FB(**)	3.1	3.1	7.2	7.6	
BF350-4FB(**)	4.0	2.6	8.1	6.9	
BF350-6FB(**)	6.0	2.8	10.4	6.9	
ZF1000-2FB(**)	2.0	3.2	5.7	7.6	
ZF1000-3FB(**)	3.0	3.2	7.1	7.8	

## QY Electronic Co., Ltd

Address: The Middle of North Tuanjie Street, Hantai District, Hanzhong City, Shaanxi Province China. Fax: +86-0916-2257989  
 Website: [www.qysensor.com](http://www.qysensor.com) Zip: 723000

# TECH SUPPORT

## HA Series Strain Gauge

CONSTRUCTION DRAWING



PRODUCT MODEL TABLE (Unit: mm)

MODEL	GRID DIM		BACKING DIM		CREEP
	L (mm)	W (mm)	L (mm)	W (mm)	
BF350-2HA	2.0	3.7	9.0	5.6	
BF350-3HA	2.8	5.5	9.7	6.7	
BF350-4HA	3.7	6.4	8.5	7.4	
BF650-3HA	2.8	4.7	8.8	5.7	
BF1000-3HA	2.8	5.5	9.7	6.7	
BF1000-4HA	3.8	6.4	8.5	7.4	

## HA-B Series Strain Gauge

CONSTRUCTION DRAWING



PRODUCT MODEL TABLE (Unit: mm)

MODEL	GRID DIM		BACKING DIM		CREEP
	L (mm)	W (mm)	L (mm)	W (mm)	
BF350-3HA-B	3.2	6.4	9.6	7.6	
BF1000-3HA-B	2.8	5.2	8.6	6.4	

## HA-C Series Strain Gauge

CONSTRUCTION DRAWING



PRODUCT MODEL TABLE (Unit: mm)

MODEL	GRID DIM		BACKING DIM		CREEP
	L (mm)	W (mm)	L (mm)	W (mm)	
BF350-3HA-C	2.8	5.6	9.8	6.8	
BF1000-3HA-C	2.8	5.6	9.8	6.8	

## QY Electronic Co., Ltd

Address: The Middle of North Tuanjie Street, Hantai District, Hanzhong City, Shaanxi Province China. Fax: +86-0916-2257989  
 Website: [www.qysensor.com](http://www.qysensor.com) Zip: 723000

# TECH SUPPORT

## HA-D Series Strain Gauge

CONSTRUCTION DRAWING

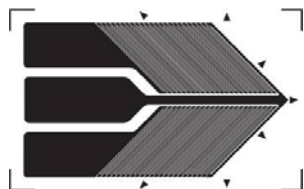

PRODUCT MODEL TABLE (Unit: mm)

MODEL	GRID DIM		BACKING DIM		CREEP
	L (mm)	W (mm)	L (mm)	W (mm)	
BF350-3HA-D	3.1	5.4	8.8	6.1	
BF1000-3HA-D	2.8	5.2	8.5	6.1	

## GB Series Strain Gauge

CONSTRUCTION DRAWING



PRODUCT MODEL TABLE (Unit: mm)

MODEL	GRID DIM		BACKING DIM		CREEP	Distance to Center mm
	L (mm)	W (mm)	L (mm)	W (mm)		
BF100-1GB-5.0	1.0	2.7	7.6	3.6		5.0; 6.0; 7.0; ----
BF350-1GB-5.8	1.0	2.7	8.2	3.6		3.8; 5.8; 7.0 ; ----
BF350-2GB-7.0	2.1	3.8	10.4	4.8		6.0; 7.0; 10.5; ----
ZF350-2GB-7.0	2	2.6	10.8	3.5		6.0; 7.0; 10.5; ----
ZF500-2GB-6.0	2	3.2	9.6	3.8		6.0; 7.0; ----
ZF700-2GB-5.8	2	3.2	9	3.8		5.8; 6.0; 7.0 ; ----
ZF1000-1.5GB-7.0	1.7	3.7	9.6	4.4		6.0; 7.0; 8.0; ----
ZF1000-2GB-7.0	2	3.6	9.9	4.4		6.0; 7.0; 10.5; ----
ZF1000-3GB-10.5	3.2	3.8	15	4.8		7.0; 10.5; ----

## GB-A Series Strain Gauge

CONSTRUCTION DRAWING

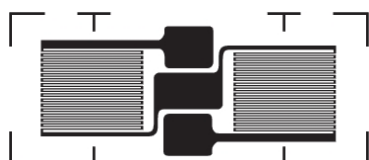

PRODUCT MODEL TABLE (Unit: mm)

MODEL	GRID DIM		BACKING DIM		Distance to Center mm
	L (mm)	W (mm)	L (mm)	W (mm)	
BF350-2GB-A-7.0	2.1	4.4	11	5.4	6.0; 7.0; 8.0; ----
ZF1000-2GB-A-7.0	2.1	4.4	11	5.4	6.0; 7.0; 8.0; ----

# QY Electronic Co., Ltd

Address: The Middle of North Tuanjie Street, Hantai District, Hanzhong City, Shaanxi Province China. Fax: +86-0916-2257989  
 Website: [www.qysensor.com](http://www.qysensor.com) Zip: 723000

# TECH SUPPORT

## FG Series Strain Gauge

CONSTRUCTION DRAWING

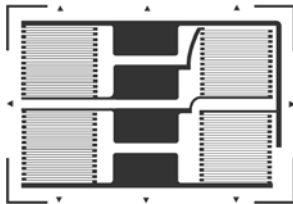

PRODUCT MODEL TABLE (Unit: mm)

MODEL	GRID DIM		BACKING DIM		Distance to Center mm
	L (mm)	W (mm)	L (mm)	W (mm)	
BF350-2FG-6.0	2.1	2.7	9.8	6.9	6.0; 10.5
ZF1000-2FG-6.0	2.1	3.1	9.6	7.8	6.0; 10.5

## FG-A Series Strain Gauge

CONSTRUCTION DRAWING

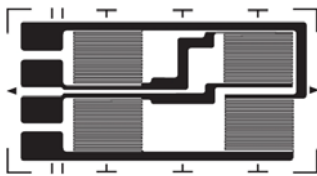

PRODUCT MODEL TABLE (Unit: mm)

MODEL	GRID DIM		BACKING DIM		Distance to Center mm
	L (mm)	W (mm)	L (mm)	W (mm)	
BF350-2FG-A-6.0	2.1	2.7	11.4	7.4	6.0; 10.5
ZF1000-2FG-A-10.5	2.3	3.1	17.4	7.8	6.0; 10.5

## FG-B Series Strain Gauge

CONSTRUCTION DRAWING

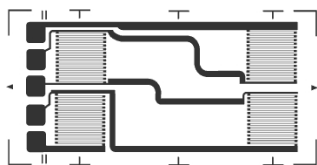

PRODUCT MODEL TABLE (Unit: mm)

MODEL	GRID DIM		BACKING DIM		Distance to Center mm
	L (mm)	W (mm)	L (mm)	W (mm)	
BF350-2FG-B-6.0	2.1	2.7	11.4	7.4	6.0; 10.5
ZF1000-2FG-B-10.5	2.3	3.1	17.4	7.8	6.0; 10.5

**QY Electronic Co., Ltd**

Address: The Middle of North Tuanjie Street, Hantai District, Hanzhong City, Shaanxi Province China. Fax: +86-0916-2257989

Website: [www.qysensor.com](http://www.qysensor.com)

Zip: 723000

# TECH SUPPORT

## KA Series Strain Gauge

CONSTRUCTION DRAWING

PRODUCT MODEL TABLE (Unit: mm)

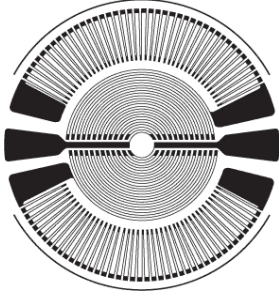

MODEL	GRID DIM	BACKING DIM	Distance to Center mm
BF350-9KA	Φ9.0	Φ10	
BF350-10KA	Φ9.0	Φ10	
ZF1000-10KA			
BF350-15KA	Φ14.2	Φ15	
ZF1000-15KA			
BF350-20KA	Φ19	Φ20	
ZF1000-20KA			
ZF350-20KA	Φ19	Φ20	
ZF1000-7KA	Φ7.0	Φ9.9	
ZF1000-13KA	Φ12.2	Φ13	
ZF1000-14KA	Φ13	Φ14	
ZF1650-13KA	Φ9.8	Φ13	
ZF2000-14KA	Φ13.5	Φ14.2	
ZF2000-18KA	Φ17.8	Φ18.2	

## QY Electronic Co., Ltd

Address: The Middle of North Tuanjie Street, Hantai District, Hanzhong City, Shaanxi Province China. Fax: +86-0916-2257989

Website: [www.qysensor.com](http://www.qysensor.com)

Zip: 723000

## PASTE STRAIN GAUGE

In the various installation methods of strain gauge, paste is common. The stand or fall of quality is one of the key factors that decide to the success of strain test. So Paste must be in strict accordance with the paste technological process when operate.

### I . Flows of paste and defend

### II . Introduction of paste strain gauge

The quality of paste is lied on the quality of polishing the strain gauge bonding site,cleaning,pasting,pressing and solidifying.Brief introduction of pasting as below:

#### 1. Polishing and cleaning

It is good for paste strain gauge by sandblast the strain gauge bonding site and best estate of surface stress, or it can use 220-400 sandpaper to polish according to the materials. Marking the 45°angle's cross stripes by the paste direction. Then wipe the bonding site in a single direction (must not reciprocated wiping) with absorbent cotton that dipping in or acetone till the absorbent cotton become white. The bonding site cannot be polluted again, like touched by hands, etc. After mark the strain gauge bonding position, use the same way to clean the surface.

#### 2. Paste strain gauge

Paste strain gauge is the key step. First, strongly brush adhesive all over the bonding site and fundus site thin and equably with technical brush. Then pick up the strain gauge with forceps, paste it along with the axes and marked lines, cover with Polyterafluoroethylene sheet, and roll press the strain gauge over the sheet with finger along with the axes direction, press out the protruding adhesive and air bubble, check the bonding situation, and adjust in the time if the strain gauge pasted in wrong position if the fundus broken, have air bubble, protrusion, then eliminate the strain gauge and paste another.

#### 3. Solidify

# TECH SUPPORT

---

The first solidify step is the key point of the solidify procedures, the adhesive will have crosslinking reaction on condition of heating and pressing. So pressure, temperature and time are the most important parameters that directly affect the adhesive. One of the most important condition for the good load cell is rationally design pressure equipment. The factory of load cell must solidify according to the specification of adhesive, and can't stop electric during solidify. The adhesive solidify technics of H-610 in our company is:

First solidify, increase pressure to 0.1~0.3Mpa, raise temperature to 135°C and keep in two hours before it return to room temperature. Last solidify, raise temperature to 165°C after decrease pressure and keep in two hours before it return to room temperature.

#### **4. Paste quality inspection**

After heating and curing, to inspect strain gauge paste quality seriously, items of Inspection:

- a. Resistance changes after Strain gauge paste;
- b. Insulation resistance;
- c. whether there is a piece of residuary bubbles inside the chips;
- d. Paste position accurate or not;
- e. Whether open circuit, short circuit or sensitive grid deformation.

### **III. Group Bridge or Welding**

If the strain gauge surface welding, before welding, waterproof abrasive paper and Contain arenaceous rubber should be used to wipe gently the glue and oxide residue in terminations surface, then clean enough, easy to weld, avoid the destruction of the terminations; The welding temperature cannot too high(normal temperature strain gauge cannot more than 250°C), welding time cannot too long, Should weld quickly, to avoid high temperature damage strain gauge's termination, reduce insulation intensity, etc. Welding lead should use wire that soft, material can not be too hard, to avoid when long-term stress, wire damage or fall off; As far as possible allow Stress release ring between the

## **QY Electronic Co., Ltd**



strain gauge welding end and the terminals of the connections, to avoid when specimen or elastomer long-term stress or temperature has great change, form internal stress concentration in the connecting, cause lead snapped, then bringing bridge road or circuit broken.

After welding, soldering flux should be cleaned, can't have remains, to avoid have impact on strain gauge insulation strength and resistance. After finished, deal with its insulation strength test again.

## **IV. Performance test (Mainly aimed at the sensor)**

### **1. Loading performance test**

Sensor clamped accurate, without shake phenomenon; loading point accurate, non displaced, had better be point-to-point loading, Test instrument adopts automatic checking method, to reduce the influence of the artificial factor; circuit connection in good condition, no contact undesirable、rosin joint etc phenomenon.

### **2. Temperature performance test**

The simulation environment temperature equipment accuracy of control temperature should be high, meet sensor test requirement, no temperature gradient、transient phenomenon; Determine the time of heat according to the sensor size, must make the sensor internal temperature even and constant, to meet the requirements of temperature, avoid the sensor elastomer internal produce temperature level; humidity conditions of the test, must make the temperature and humidity of the surrounding environment to specified requirements.

### **3. Environmental requirement**

Indoor environment conditions must be up to national standards, to reduce the influence of environment on the sensor.

## **V. Preservative treatment**

The installed strain gauge should take reliable and practical measures of protection, is an effective

## TECH SUPPORT

---

way to guarantee the normal work, improve the strain gauge measuring precision. The basic way of Strain gauge protection, is using certain materials or medium to separate strain gauge together its attachment from severe environment. First, in the strain gauge installation and use process, carefully and cautiously operation, keep not contact directly with the hand is an effective protective measure; second, using coating layer for protection, the protection of strain gauge can be chosen commonly AZ-709 glue, to protect part of bare, required painted in uniform, then covers Ntu 703,704,D04 Silicone rubber.

### QY Electronic Co., Ltd

Address: The Middle of North Tuanjie Street, Hantai District, Hanzhong City, Shaanxi Province China. Fax: +86-0916-2257989  
Website: [www.qysensor.com](http://www.qysensor.com) Zip: 723000